

e88  **USER'S GUIDE**

© Copyright 2003 PerComm, Inc. All rights reserved.

Manual Part Number: 9626-01001-01

Sept 23, 2003

Contents

<p>1. Safety Information 4</p> <p>2. Getting Started 6</p> <p>2.1 Unpacking Your e80 6</p> <p>2.2 Attaching a Lanyard Cord 6</p> <p>2.3 Installing the Battery 6</p> <p>2.4 Charging the Battery 7</p> <p>2.5 Using the e80 Holster 7</p> <p>3. About Your e80 9</p> <p>3.1 The External Connector 9</p> <p>3.2 The Back Light 9</p> <p>3.3 The LCD Display 10</p> <p>3.4 The Keyboard 12</p> <p>3.5 Shortcuts for Navigating 14</p> <p>3.6 Navigation Conventions in this Manual 15</p> <p>3.7 Your Personal Memory 16</p> <p>4. Setting Up Your e80 17</p> <p>4.1 Viewing System Information 17</p> <p>4.2 Entering Owner Information 18</p> <p>4.3 Setting Date and Time 19</p> <p>4.4 Turning Your e80 Off and On 19</p> <p>4.5 Main Menu Options 20</p> <p>5. Sending Messages 22</p> <p>5.1 Selecting a Contact from the Address Book 22</p> <p>5.2 Adding or Editing a Manual Address Entry 24</p> <p>5.3 Composing your Message 24</p> <p>5.4 Sending your Message 25</p> <p>6. Managing Incoming Messages 26</p> <p>6.1 Reading a Message 26</p> <p>6.2 Replying to a Message 28</p> <p>6.3 Forwarding a Message 29</p> <p>6.4 Deleting Messages 29</p> <p>6.5 Erred Messages 29</p> <p>7. Managing Outgoing Messages 30</p> <p>7.1 Reviewing Sent Messages 30</p> <p>7.2 Resending a Message 30</p> <p>7.3 Deleting Messages 30</p> <p>8. Other Messaging Options 31</p> <p>8.1 Creating Quick Text for Messages 31</p> <p>8.2 Customizing the New Message Alert 32</p> <p>8.3 Setting a Message Timestamp 33</p> <p>8.4 Creating an Automatic Signature 34</p>	<p>8.5 Saving Messages in the Personal Folder ... 34</p> <p>9. Managing the Address Book 35</p> <p>9.1 Adding a Contact to the Address Book 35</p> <p>9.2 Setting the Default Address within a Contact 36</p> <p>9.3 Adding a Group to the Address Book 37</p> <p>9.4 Viewing Contact or Group Information 38</p> <p>9.5 Editing a Contact or Group 39</p> <p>9.6 Deleting a Contact or Group 39</p> <p>10. Reading News 40</p> <p>10.1 Reading a News Message 40</p> <p>10.2 Forwarding News 40</p> <p>10.3 Deleting News 41</p> <p>10.4 Reordering News Folders 42</p> <p>10.5 Customizing News Alerts 42</p> <p>10.6 Saving News in the Personal Folder 43</p> <p>11. Creating and Managing Memos 44</p> <p>11.1 Creating a Memo 44</p> <p>11.2 Viewing a Memo 44</p> <p>11.3 Editing a Memo 45</p> <p>11.4 Deleting a Memo 45</p> <p>11.5 Inserting a Memo into a Message 45</p> <p>12. Managing Folders 46</p> <p>12.1 Creating a New Subfolder for Mail or News Messages 46</p> <p>12.2 Editing a Subfolder Name 47</p> <p>12.3 Deleting Subfolders 47</p> <p>12.4 Managing Draft Messages 47</p> <p>12.5 Managing Personal Messages 48</p> <p>13. Setting Personal Options 49</p> <p>13.1 Setting Up the Alarm Clock 49</p> <p>13.2 Alarm Alerts 51</p> <p>13.3 Customizing Display Features 51</p> <p>13.4 Setting Private Time 52</p> <p>14. Maintenance 54</p> <p>14.1 General Care 54</p> <p>14.2 Battery Care 54</p> <p>15. Troubleshooting 55</p> <p>16. FCC Compliance Statement 56</p> <p>Index 57</p>
---	--

1. Safety Information

IMPORTANT INFORMATION ON SAFE AND EFFICIENT OPERATION.

READ THIS INFORMATION BEFORE USING YOUR e80 PERSONAL MESSAGING DEVICE.

RF Operational Characteristics

Your e80™ device contains a transmitter and a receiver. When it is ON, it receives and transmits radio frequency (RF) energy. The e80 operates in the frequency range of 900 MHz and employs digital modulation techniques.

When you communicate with your e80, the output power level is typically 1 watt.

Exposure to RF Energy and EMI

Your e80 is designed to comply with the United States Federal Communications Commission (FCC), Code of Federal Regulations; 47 CFR part 2 sub-part J guidelines regarding exposure of human beings to RF electromagnetic energy.

To assure optimal e80 performance and make sure human exposure to RF electromagnetic energy is within the guidelines set forth in the above standards, always adhere to the following procedures:

Body-worn Operation

To maintain compliance with FCC RF exposure guidelines, if you wear an e80 on your body when transmitting, always place the e80 in a PerComm supplied or approved holster. Use of non-PerComm-approved accessories may exceed FCC RF exposure guidelines. If you do not use a body-worn accessory, ensure the device is at least 0.5 cm from your body when transmitting.

Electromagnetic Interference/Compatibility

Note: Nearly every electronic device is susceptible to electromagnetic interference (EMI) if inadequately shielded, designed or otherwise configured for electromagnetic compatibility.

- **Public Facilities**

To avoid electromagnetic interference and/or compatibility conflicts, turn off your e80 in any facility where posted notices instruct you to do so. Hospitals or health care facilities may be using equipment that is sensitive to external RF energy.

- **Aircraft**

When instructed to do so, turn off your e80 when on board an aircraft. Use of an e80 must be in accordance with applicable regulations per airline crew instructions.

- **Medical Devices**

Pacemakers: The Health Industry Manufacturers Association recommends that a minimum separation of 6 inches (15 centimeters) be maintained between a handheld wireless communication device and a pacemaker. These recommendations are consistent with the independent research by, and recommendations of, Wireless Technology Research.

Persons with pacemakers should:

- ALWAYS keep the e80 more than six inches (15 centimeters) from their pacemaker when the e80 is turned ON.
- Not carry the e80 in the breast pocket.
- Turn the e80 OFF immediately if you have any reason to suspect that interference is taking place.

Hearing Aids: Some digital wireless e80s may interfere with some hearing aids. In the event of such interference, you may want to consult your hearing aid manufacturer to discuss alternatives.

Other Medical Devices: If you use any other personal medical device, consult the manufacturer of your medical device to determine if it is adequately shielded from RF energy. Your physician may be able to assist you in obtaining this information.

Use While Driving

Check the laws and regulations on the use of wireless communication devices in the area where you drive. Always obey them. It is strongly recommended that you not use your e80 while driving:

- Give full attention to driving and to the road.
- Pull off the road and park before using your e80 for any reason.

Operational Warnings

For Vehicles with an Air Bag

Do not place a portable e80 in the area over an air bag or in the air bag deployment area. Air bags inflate with great force. If the e80 is placed in the air bag deployment area and the air bag inflates, the e80 may be propelled with great force and cause serious injury to occupants of the vehicle.

Potentially Explosive Atmospheres

Turn off your e80 prior to entering any area with a potentially explosive atmosphere. Do not remove, install, or charge batteries in such areas. Sparks in a potentially explosive atmosphere can cause an explosion or fire resulting in bodily injury or even death.

Important: The areas with potentially explosive atmospheres referred to above include:

- fueling areas
- below deck on a boat
- fuel or chemical transfer or storage facilities
- areas where the air contains chemicals or particles such as grain, dust or metal powders
- any other area where you would normally be advised to turn off your vehicle engine.

Areas with potentially explosive atmospheres are often but not always posted.

Blasting Caps and Blasting Areas

To avoid possible interference with blasting operations, turn off your e80 when you are near electrical blasting caps, in a blasting area, or in areas posted: "Turn off two-way radio." Obey all signs and instructions.

Operational Cautions

Batteries

The PerComm lithium ion battery contains a built-in protection circuit, however, all batteries can cause property damage and/or bodily injury such as burns if a conductive material (for example: keys, beaded chains, or jewelry) touches exposed terminals. The conductive material may complete an electrical circuit (short circuit) and become quite hot. Exercise care in handling any charged battery, particularly when placing it inside a pocket, purse, or other container with metal objects.

2. Getting Started

2.1 Unpacking Your e80

Your e80 comes with the following parts and accessories:

- PerComm 3.6V lithium ion battery
- Battery Charger
- Holster
- CD-ROM
- e80 Quick Start Guide
- Optional RS232-compatible serial cable.

2.2 Attaching a Lanyard Cord

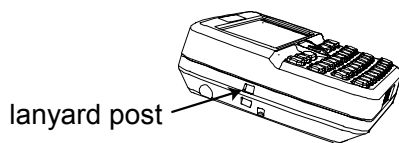

A post is provided on the left side edge of the e80 (with the display and keyboard facing towards you) for attaching a lanyard cord.

2.3 Installing the Battery

The battery cabinet is protected by a battery cover that can be removed by pressing down on the thumb grip and sliding outwards. The cabinet itself is designed expressly for PerComm lithium ion batteries, and does not accept any other type of battery. Attempting to use any other type of battery will cause damage to your e80.

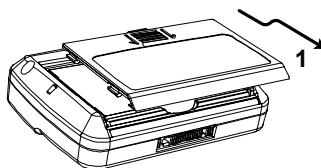

1. Press down and slide cover off.

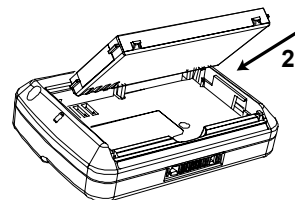

2. Push top edge of battery firmly into cabinet.

- Label must be facing outwards.
- Contacts on battery and cabinet must align.

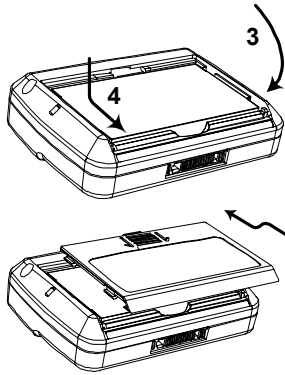

3. Swing battery down flat into cabinet.

4. Press battery firmly down and slide fully back.

**Battery should snap in easily if properly aligned!
Do not force.**

5. Insert cover tabs into slots in cabinet edges. Press cover into place and slide fully closed.

2.4 Charging the Battery

Charge the PerComm battery as described below. The battery icon will indicate when the battery is fully charged. You must charge your battery before using your e80 for the first time. Your e80 will automatically power on during the first few minutes of charging.

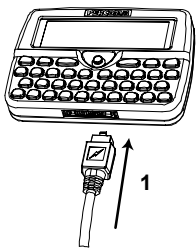

1. Connect battery charger:

- Plug transformer into 115VAC power source.
- Snap power cable into right side of e80 connector.
- **IMPORTANT:**  on connector must face up!
- Charging will begin and battery status icon will flash.
- Charging is complete when icon stops flashing.

2. Disconnect battery charger:

- Unplug cable by bending it sharply down or up.
- Do not pull cable straight out.

Your e80 is now ready to use.

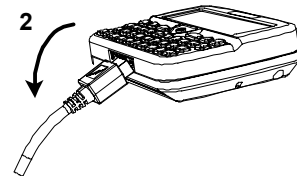

2.5 Using the e80 Holster

A belt-worn holster is provided with your e80.

After attaching the holster to your belt (using the belt clip on the back of the holster), insert your e80 into the holster with the LCD display at the top, facing inward.

The battery housing faces outward in the holster, with the thumb grip at the top.

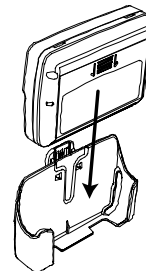

The e80 is held firmly in place and can be easily grasped and removed when you need to use it.

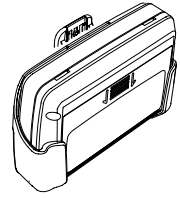

3. About Your e80

The main features of your e80 are the LCD display, the keyboard, the joystick, the external connector on the front edge, and the battery cabinet on the rear. Figure 1 below shows the front panel and front and side edges of the e80.

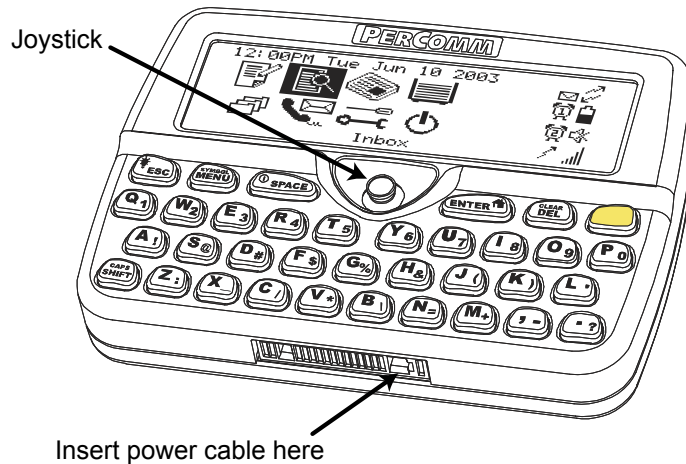

Figure 1: e80 Front Panel

3.1 The External Connector

An external connector is located on the front edge of your e80. You can plug in either the 110 V AC/DC power transformer cable to recharge your battery, or the serial cable to exchange information between your e80 and a personal computer. The serial connector plug uses the entire external connector; the power connector plug only uses the right side of the e80 external connector.

3.2 The Back Light

The LCD display and keyboard keys can be backlit for use in low light conditions. Use the **ESC** key to turn the back light on and off.

1. To turn ON the back light, press **ESC** and hold down for 2 seconds until the back light turns on. The LCD display and all key labels will be lit.
2. To turn OFF the back light, press **ESC** and hold down 2 seconds until the back light turns off.

The back light will turn off automatically after the device has been idle (i.e. a key has not been pressed) for a period of time. You can specify the idle time length in the Preferences menu: Options → Screen Timeout (see *Customizing Display Features* on page 51).

3.3 The LCD Display

As soon as you insert a charged PerComm battery in your e80, the LCD screen will show a display of icons in two groups. The larger icons to the left are the Main Menu; the smaller icons to the right are the Status Indicators.

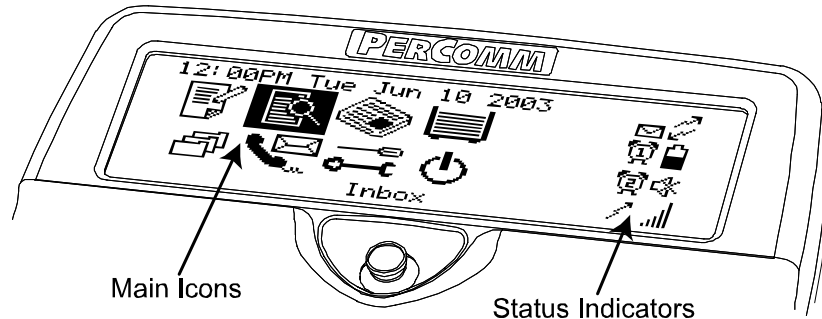









Figure 2: LCD Display

The Main Menu

The Main Menu displays icons that allow you to select the different functions of your e80. In the order that they appear (left to right, top to bottom), the icons represent the following functions:

Selecting this Icon...	displays....
 SEND A MESSAGE	...the Compose Message screen. You can create and send messages here.
 INBOX	...the contents of the Message Inbox (received messages). You can read and respond to incoming messages here.
 NEWS	...the contents of the News Inbox (received messages and subfolders). You can read News messages here.
 OUTBOX	...the contents of the Message Outbox (sent messages). Outgoing messages are stored here.
 FOLDERS	...folders of memos, draft messages, and archived messages. You can create memos, edit draft messages and archive news and mail messages here.
 ADDRESS BOOK	...the Address Book list of contacts and groups. You can create and store addresses here.
 PREFERENCES	...a list of Preference options that you can customize.
 POWER OFF	Turns the e80 OFF.

To access any of the options listed above, follow these steps:

1. Push the joystick left, right, up (away from you) or down (toward you) until the desired icon is highlighted. The name of each icon appears at the bottom of the display as it is highlighted.
2. Press the joystick (into the device), or, press **ENTER**. The menu for the selected icon appears on the display.

System Status Indicators

Status indicators are smaller icons on the right side of the LCD display screen. Their appearance tells you important status information about your e80. The next two tables describe the status indicators that you may see on your e80 Main Menu display, from left to right and top to bottom:

First column of status indicators:

Unread Inbox Messages:		Appears when there are Unread messages in the Inbox. Flashes when there are new Unread messages.
Alarm#1:		Only appears when alarm #1 is set. Flashes when in Snooze Mode.
Alarm #2:		Only appears when alarm #2 is set. Flashes when in Snooze Mode.
Message Transmitting:		Appears and flashes while message is transmitting. Disappears when the transmission is completed.
		Appears when the transmitter is turned off.

Second column of status indicators:

Coverage:	2-Way	1-Way	No Coverage
Battery Life:	Battery icon, 50% charge remaining	Battery charging	
Alert Setting:	Tone	Vibrate	Silent
Signal Strength*:	High	Medium	Low

*Note: Signal Strength is visible if enabled by your service provider.

To view more detailed information for each status indicator:

1. While the Main Menu is displayed, press **MENU**. A popup menu appears on the right side of the screen.
2. Push the joystick down (toward you) until the item "Go To Status Icons" is highlighted.

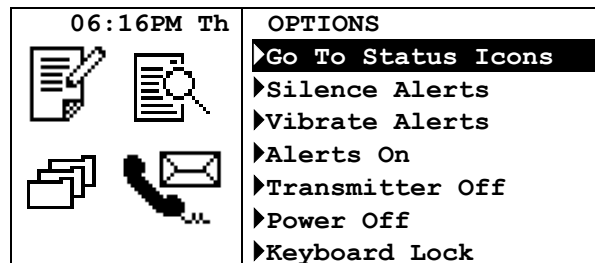

3. Press the joystick (into the device). The top icon in the first column of status indicators is highlighted, and text describing the icon appears at the bottom of the screen.

4. Push the joystick right, left, up (away from you) or down (toward you) to move from icon to icon. Detailed information about each icon appears at the bottom of the screen as the icon is highlighted.





For example, when the Battery Life icon is highlighted, the text "Battery: N%" will appear at the bottom of the screen ('N' is the percentage of charge remaining on the battery).

5. Press **ESC** to return to the Main Menu.

Device Mode Indicators

Device mode indicators appear in the upper right corner of the LCD display when certain device modes are in effect. They will not appear on the Main Menu display, but can appear in other screen displays. For example, the Caps Lock icon will appear when you press the Shift key twice to enable Shift Lock.

This Indicator... tells you...

	SHIFT (for typing a single uppercase letter) or SHIFT Lock (for multiple uppercase letters) is on.
	ALT (for typing a single number or special character) or ALT Lock (for multiple numbers/special characters) is on.
	You can scroll UP to view more text or menu items.
	You can scroll DOWN to view more text or menu items.

3.4 The Keyboard

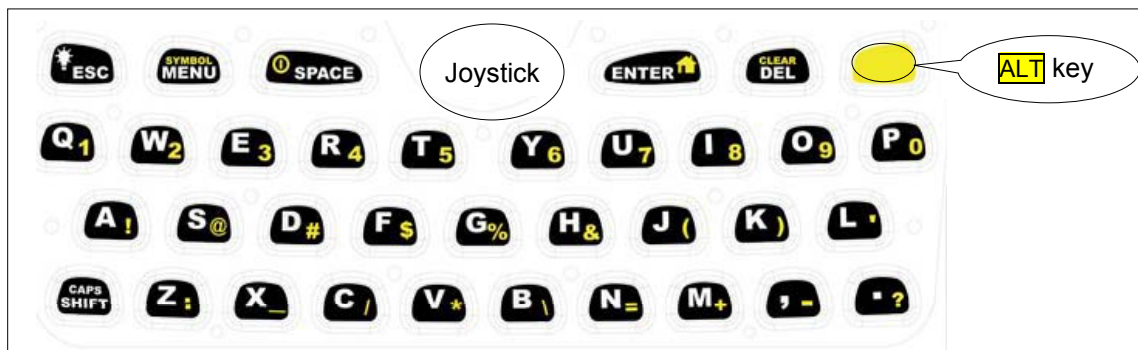

Figure 3: The e80 Keyboard

The keyboard contains two different kinds of keys:

- Control (function) keys
- Text entry keys.

Control Keys

The Control keys are located in the top row of the keyboard (except the **SHIFT** key, which is in the lower left corner of the keyboard). The control keys can be used to do the following:

Press this key ...to do this:

ESC	– Once to exit from current submenu or text screen. – Hold to turn backlight on or off.
MENU	– Display a popup menu on the right side of the screen, if one is available.
ENTER	– To display a highlighted menu. – Page down while viewing a message.
DEL	– Delete one character to the left of the cursor.
SHIFT	– Once to type an uppercase letter; – Twice for Caps Lock (all uppercase); – Once again to return to lowercase characters.
ALT	– Once to type a number or special character (yellow on text entry keys); – Twice for Alt Lock (all numbers or special characters); – Once again to return to normal characters.
ALT-MENU	– Access special symbols not displayed on the keyboard text entry keys.
ALT-SPACE	– Turn off the e80.
ALT-ENTER	– Return to Main Menu.
ALT-DEL	– Clear (delete) all characters in the current field; – Delete current message/memo/Quick Text in the list screen.
ALT-L	This is a special key sequence that locks/unlocks the keyboard from the Main Menu.

Note the following:

- There is no label on the **ALT** key (on the keyboard). It is simply colored yellow.
- To execute the above 2-key functions, the **ALT** key must be released before pressing the next key. For example, to turn the e80 off, press the **ALT** key, and then press the **SPACE** key.

Text Entry Keys

Each regular keyboard key is capable of producing 3 kinds of text:

- Lowercase characters
- Uppercase characters (use **SHIFT** to access them)
- Special characters and numbers (appear yellow on text entry keys, use **ALT** to access them).

3.5 Shortcuts for Navigating

After you have mastered the basics of navigation using a combination of the **MENU**, **ESC**, **ENTER**, and joystick, you may want to use some of the shortcuts. The shortcuts will enable you to navigate through the menus more quickly.

Shortcuts for basic navigation

In most screens and all Option Popup Menus:

Use this shortcut...	...in place of...
Push joystick ← to return to previous menu (left)	pressing ESC
Push joystick → to display a popup menu on the right (right)	pressing MENU
Press joystick (inward) to display a highlighted menu, screen or message	pressing ENTER

Shortcuts for viewing Messages/Memos/Quick Text

While viewing a message, memo or Quick Text, the following shortcuts can be used:

Use this shortcut...	...in place of...
Push joystick ← to display previous message (left)	pressing MENU and selecting <i>Previous Message</i>
Push joystick → to display next message (right)	pressing MENU and selecting <i>Next Message</i>
Press joystick (inward) to display a popup menu on the right	pressing MENU
Press ENTER to page down one screen	pressing joystick ↓ (down) multiple times

Shortcuts for editing Messages (Send a Message)/Memos/Quick Text

While editing a message, memo or Quick Text, the following shortcut can be used:

Use this shortcut...	...in place of...
Press joystick (inward) to display a popup menu on the right	pressing MENU

Shortcuts for Send a Message To: field

While in the **To:** field in Send a Message, you may want to use the following shortcuts:

Use this shortcut...	...in place of...
Press joystick (inward) to display the Address Book	pressing MENU and selecting Select Address
Enter characters to display the manual address entry screen	pressing MENU and selecting Manual Entry

Shortcuts for the Address Book

While viewing the address book list (either through Send a Message or Address Book), you may use the following shortcuts:

Use this shortcut...	...in place of...
Push joystick ← (left) to return to previous menu	pressing ESC
Push joystick → (right) to display a popup menu on the right	pressing MENU
Press joystick (inward) in Address Book: to display the contact	pressing ENTER
Press joystick (inward) in Address Book via Send a Message: to select or unselect the contact	pressing ENTER
Press first letter of Contact name to search for Contact name beginning with that letter	pressing pressing joystick ↑ (up) or ↓ (down) multiple times

3.6 Navigation Conventions in this Manual

In this manual various operations are described using the navigation conventions described below.

This...	means....
Go to PREFERENCES → Options	In the Main Menu, push the joystick until the PREFERENCES icon (☰) is highlighted. Press the joystick (or press ENTER) to display the Preferences menu. Push the joystick ↑ (up) or ↓ (down) until the ▶ Options item is highlighted (▶ Options). Press the joystick to display the Options submenu.
Select New Folder	Push the joystick ↑ (up) or ↓ (down) until the menu item ▶ New Folder is highlighted (▶ New Folder). Press the joystick to display the New Folder screen.

This...	means....
Set to "Yes"	In an option field, press the joystick until "Yes" is displayed.
Open a popup menu	Press MENU or push the joystick → (right). In Edit Text or View Message Modes, you cannot push the joystick → (right) to open the popup menu, you must press MENU .

3.7 Your Personal Memory

Your device contains 3 different areas of memory: Personal, Address Book, and News. Each area of memory can contain different amounts of information as customized by your service provider. The following are stored in the Personal Memory area:

- Inbox
- Outbox
- Folders (Drafts, Memos, Personal Folder)
- Quick Text

Automatic Deletion when Personal Memory is Full

Eventually your Personal Memory will get full if you don't delete messages from your Outbox and Inbox, or if you store many messages/memos in Folders. Your e80 will automatically delete Inbox and Outbox messages to make room for new incoming Inbox messages, or new outgoing messages (including replies and forwards), or new memos. The order of priority for automatic deletion is:

1. The oldest Inbox messages marked as Read, or Outbox messages marked as failed or sent, are deleted first.
2. If all of the above messages have been deleted, then the oldest Inbox messages marked as Unread are deleted.

Go to **PREFERENCES** → **About** to see the amount of Personal Memory being currently consumed.

Note: If you do not want a message to be automatically deleted when Personal Memory gets full, then you must move that message into a Personal Folder.

4. Setting Up Your e80

Your e80 comes with certain options already set for you. You can change any of the options listed in the Preferences Menu. Some settings, such as Owner Information and Signature, are not set in advance, so you will want to configure them as soon as possible.

4.1 Viewing System Information

To view useful system information about your e80:

1. Select the **PREFERENCES** icon in the Main Menu.
*Push the joystick to move to the Preferences icon (it will be highlighted), then press the joystick in (or press the **ENTER** key) to select it.*

The Preferences menu appears in the LCD display.

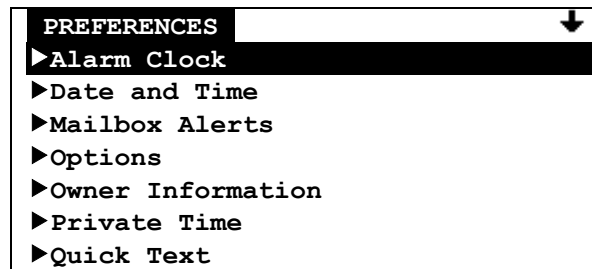

Arrow in the top right corner indicates that there are more options below, use the joystick to scroll downward.

This view and others in the manual show an 8-line display; for a larger font you can also set your e80 to display only 5 lines. See *Customizing Display Features* on page 51.

2. Select **About** from the Preferences menu.
*Push the joystick ↓ (down, or away from the LCD display) until **About** appears in the display and is highlighted:*

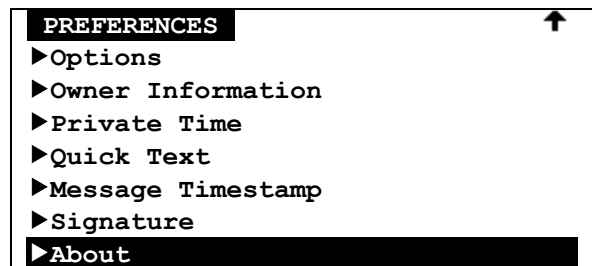

Arrow in the top right corner indicates that there are more options above, use the joystick to scroll upward.

3. Press the joystick, or press **ENTER** to display the About screen:

ABOUT		↓
Coverage:	2 way	- network service level
Battery Charged:	80%	- % battery charge level
Memory Used		- % of memory used in:
Personal:	13%	Personal Area
Address Book:	55%	Address Book
News:	21%	News
Serial Number:	123456	- device serial number
S/W version:	2.03	- software version number

4. When finished, push the joystick ← to exit from the About display and return to the Preferences menu.

For more information about Personal Memory see Section 3.7 Your Personal Memory.

4.2 Entering Owner Information

To enter personal contact information:

1. Go to **PREFERENCES** → **Owner Information**.
The Owner Information screen appears.
You can move between each entry field by pushing the joystick ↑ or ↓.
2. Enter text, using the keyboard:

OWNER INFORMATION
Name: <input type="text"/>
Phone: <input type="text"/>
Comment: If found please phone <input type="text"/>

When the cursor is in the Phone: field, Alt Lock is set automatically for entering numbers, you will see  in the upper right corner of the display.

3. Press **ESC** to exit from the Owner Information screen. Your changes are automatically saved. The Preferences submenu is displayed.

4.3 Setting Date and Time

To set the correct date and time on your e80:

1. Go to **PREFERENCES** → **Date and Time**.
The Date and Time submenu is displayed.

DATE AND TIME	
Time Format:	12hr
Time:	04:39 PM
Date:	May 28 2003
Network Sync:	Yes

*If Time Format is set to 24hr, then **PM** or **AM** will not be displayed.*

2. Use the joystick to move from one field to another, and press the joystick to change options in each selectable field.
3. Set **Time Format** to "24hr" (for 24-hour clock format) or "12hr" (for 12-hour clock format).
4. Set the current **Time**:
HH (00–23 for 24-hour format, or 01–12 for 12-hour format)
MM (set automatically by system if **Network Sync** set to Yes)
AM/PM (only if 12hr format selected).

If 24-hour format has been selected, then nothing is displayed in the AM/PM field.
5. Set the current **Date**:
MMM ("Jan", "Feb", "Mar", etc.)
DD (01–31)
YY (00-99).
6. If **Network Sync** is set to Yes, then the device will automatically set the minutes of the **Time**.
7. Press **ESC** to exit from Date and Time. Your changes are automatically saved.

4.4 Turning Your e80 Off and On

You can turn OFF your e80 by selecting the **POWER OFF** icon in the Main Menu.

Turn the device back ON by pressing **ALT** and then **SPACE**.

The Main Menu icons will appear in the LCD display when it is on again.

Note: Two additional methods of turning off the device are:

- Pressing **ALT** and then **SPACE**
- Or, pressing **Power Off** in the Main Menu popup options menu

4.5 Main Menu Options

The Main Menu options menu lets you quickly access the different features of the e80. You can quickly change your alert sound to vibrate or silent, turn off message transmission, and view device status information.

To change your alert sound:

1. Press **MENU** and select:
 - **Silence Alerts** to turn off your alert sound (note: alarm alerts are not affected)
 - **Vibrate Alerts** to change your alert sound to vibrate (note: alarm alerts are not affected).

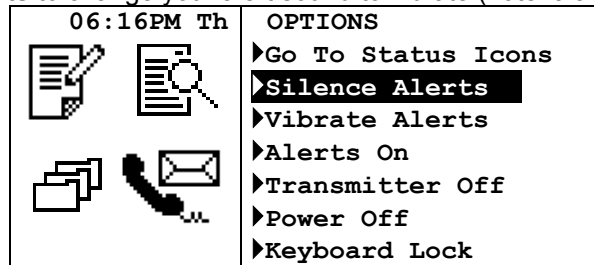

2. Return to your default alert setting by selecting **Alerts On** (note: alarm alerts are not affected).

To turn off message transmission:

1. Press **MENU** and select **Transmitter Off**.

You can receive messages, but will not be able to send messages until you turn message transmission on again. The icon  will display on the Main Menu screen when the transmitter is off. Your device will not transmit when the transmitter is off!

2. Turn message transmission back on by selecting **Transmitter On**.

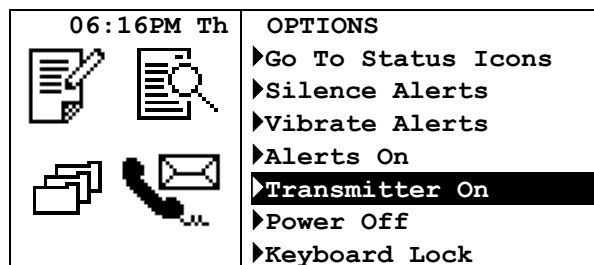

To turn your e80 off (alternative method):

1. Press **MENU** and select **Power Off**.
2. Turn the e80 back on by pressing **ALT** then **SPACE**.

To view additional status information:

1. Press **MENU** and select *Go to Status Icons*.

2. The popup menu closes and the cursor is now on one of the status icons on the right side of the screen.
3. Push the joystick ←, →, ↑ or ↓ to select the desired status icon and view status information at the bottom of the screen.
4. Return to the Main Menu by pressing **ESC**, or by selecting **Go to Main Menu** in the popup menu.

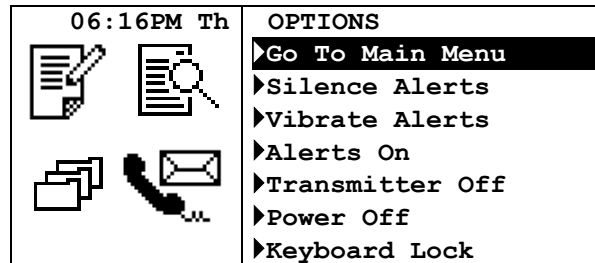

To lock your keyboard:

1. Press **MENU** and select **Keyboard Lock**. Alternatively, you may lock the keyboard from the Main Menu by pressing **ALT** then **L**.
2. Unlock the keyboard by pressing **ALT** then **L**.

5. Sending Messages

You can compose and send messages to wireless and email addresses.

To start, select **SEND A MESSAGE** in the Main Menu.

The Send A Message screen is displayed:

*Cursor is in the **To** field.*

Note: For shortcuts see Section 3.5 Shortcuts for Navigating on page 14.

5.1 Selecting a Contact from the Address Book

You can select contacts (or groups) from your Address Book to be in your **To** field. To use this option you must first create the contacts and groups in the Address Book (see *Adding a Contact to the Address Book* on page 35).

To select a contact to be in your message **To** field:

1. Press **MENU** to open the Message Options popup menu.

2. Select **Select Address**. The Address Book contact list is displayed. (A faster way of getting to the Address Book, is to press the joystick while in the **To** field.)

- *Indicates that this contact has been selected.*

* Indicates that this contact has a "Frequent" setting, which puts the name at the top of the Address Book list of contacts.

3. Select one or more names from the Address Book.
A bullet (•) will be shown when the joystick is pressed for that name. To unselect a contact, press the joystick again.
4. Push the joystick ← to exit the Address Book.
The name(s) you have selected will appear in the **To** field.
There is only one display line for the **To** field, so if several contacts were selected, they may not all fit on the display.
5. To view all addresses in the **To** field, push the joystick ↑ so that the **To** field is highlighted, and press **MENU** to open the Options popup menu again.
6. Select **View Selected** in the popup menu to display a complete list of contacts that have been added to the **To** field.

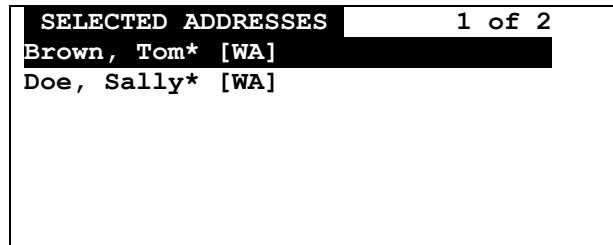

Save a Draft of your Message

At any time you can save your message for completing later.

1. While editing your message, press **MENU** to open the Options popup menu.
2. Select **Save to Draft**.
The message will be saved in your Drafts folder (see *Managing Folders* on page 46).

Later, you can go to the Drafts folder and edit, delete or send the draft message (see *Managing Draft Messages* on page 47).

Sending to Non-Default Addresses

You may send to a contact's non-default addresses.

1. While selecting contacts in the Address Book, press **MENU** to open the Options popup menu.

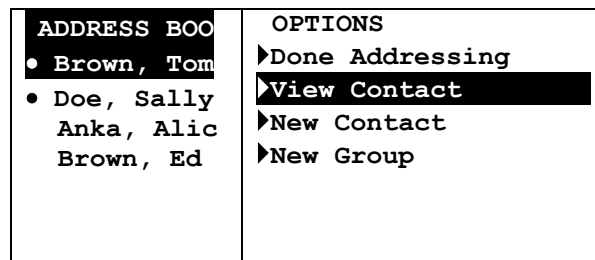

2. Select View Contact
3. Select one or more addresses.
A bullet (•) will be shown when you press the joystick for that name.
4. Press **MENU** to open the Options popup menu

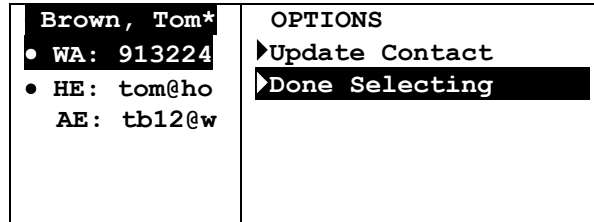

Select **Update Contacts** to save the changes permanently into the Address Book, or select **Done Selecting** to use the changes for this message only.

5.2 Adding or Editing a Manual Address Entry

You can add an address manually, or edit a manual address you have already entered.

1. With the cursor in the **To** field, press **MENU** to open the Message Options popup menu.
2. Select **Manual Entry** to open the Manual Entry display.
3. Type the address (or edit an existing address).

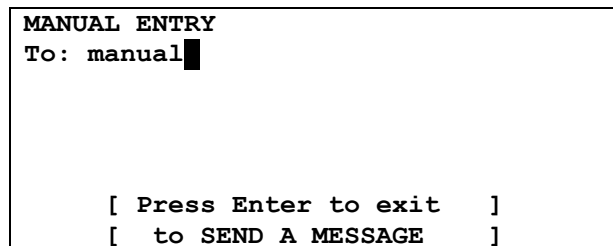

4. Press **ENTER** to save text and exit the Manual Entry screen.

Alternatively, when the cursor is on the **To** field in the Send a Message screen, you may start typing the manual address, and the device will automatically open up the Manual Entry screen.

5.3 Composing your Message

Move the cursor (push the joystick ↓) to the **Msg** field and type your message.

You can also add Quick Text or Memos to your message (see *Creating Quick Text for Messages* on page 31 and *Creating a Memo* on page 44). Quick Text is a preset phrase that you have created and saved in your Quick Text menu. Memos are text files that you have created and saved in your Memos folder.

Add Quick Text or Memos to your Message

1. With the cursor in the **Msg** field, press **MENU** to open the Message Options popup menu.

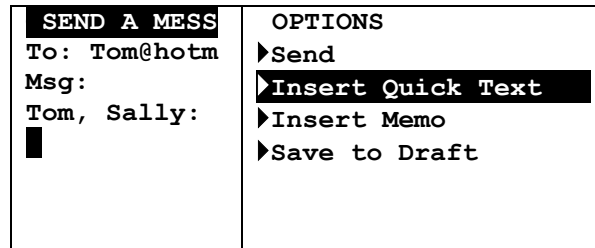

2. Select **Insert Quick Text** from the popup menu.
A list of Quick Text messages is displayed.
3. Select the desired Quick Text from the list.
The list closes and the Quick Text is inserted at the cursor in the message area.

You can also insert memos in a similar manner, by selecting **Insert Memo** from the popup menu (see Creating a Memo on page 44).

Note: For shortcuts see Section 3.5 Shortcuts for Navigating on page 14.

5.4 Sending your Message





1. When you have completed your message, press **MENU** to open the Message Options popup menu.
2. Select **Send**.
The popup menu closes automatically when the message is sent.

You will see the Message Transmission status symbol flashing in the Main Menu display until the message transmission is completed. Your sent message is saved in the **OUTBOX**.

For more information see Section 7 Managing Outgoing Messages on page 30.

6. Managing Incoming Messages

Received personal messages are stored in your Inbox. Each message has a symbol indicating its current status:

-  Unread message
-  Read message
-  Message has been forwarded.
-  Message has been replied to.
-  Message forward or reply failed.

A brief preview of a selected message is displayed in the bottom two lines of the screen.

If you subscribe to a News service, news messages are not stored in the Inbox but are stored in News. See *Reading News* on page 40.

Select **INBOX** in the Main Menu to display the personal messages that you have received.

Note: For shortcuts see **Shortcuts for Navigating on page 14.**

6.1 Reading a Message

1. Select **INBOX** in the Main Menu.
A listing is displayed of all messages in your Inbox, organized from the newest (at the top) to the oldest.

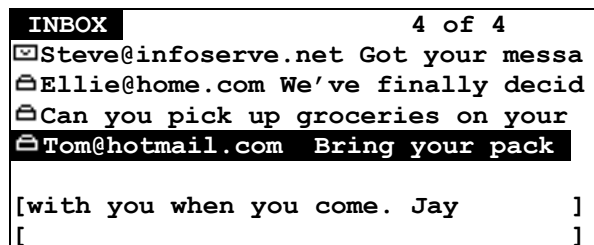

Text in [brackets] at bottom of display is a continuation of the highlighted message text.

2. Scroll through the Inbox menu of received messages to the desired message.
3. Press the joystick to open the message for viewing.
4. Press **ESC** to return to the Inbox when finished reading the message.

Reading a Message with Quickview

If a Quickview New Message Received popup is displayed, select "Yes" in the popup to display the message.

Quickview is a quick way to read messages on your e80. The Quickview popup appears on the display as soon as a new message arrives in the Inbox, and selecting "Yes" in the popup immediately opens the message for viewing. For information on setting up the Quickview alert, see *Customizing the New Message Alert* on page 32. Note that the Quickview popup does not allow you to view the new message if you are currently editing a message or a memo.

6.2 Replying to a Message

1. Scroll to the desired message in your **INBOX** and press **MENU** to open the Inbox Options popup menu.

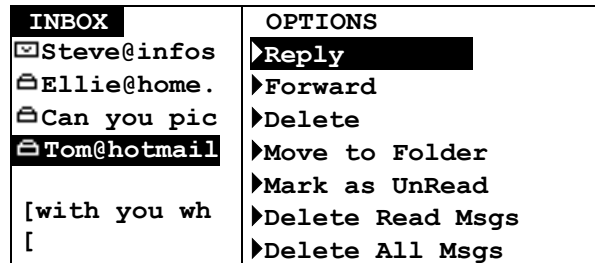

You can press **MENU** at any time to open a popup menu. If you open the Inbox Options popup *after* opening a message, the menu will have different options listed than if you open the popup menu *before* opening the message.

2. Select **Reply** to open the Reply Options menu.

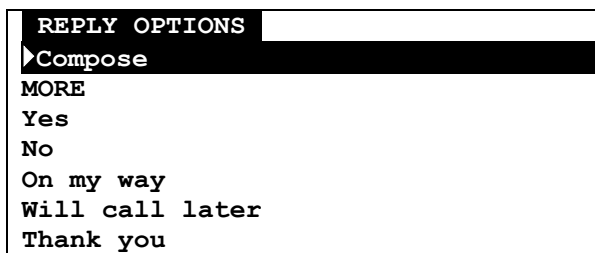

3. Select **Compose** to open the Reply screen;

Or:

Select an automatic response to automatically send the selected reply message. An automatic response is any selection other than **Compose**.

You can have a set of system-generated automatic responses that are always there and optional MCR (Multiple Choice Responses) responses that may or may not be available for any particular message.

For example, "MORE" is an optional MCR that prompts the system to send the next portion of a long message. If this MCR appears, you can continue to reply **MORE** until the entire message has been received.

If you select an automatic response (for example, **MORE**, **Yes**, **No**, etc) the reply is immediately sent. The reply screen will be closed and the user will be returned to the Inbox list screen.

- If **Compose** was selected, type your message, then press **MENU** to open the popup menu for more options:

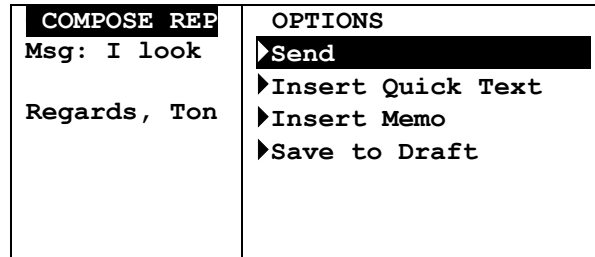

- Select **Send** to send the message.

6.3 Forwarding a Message

- Scroll to a message in the **INBOX** menu and press **MENU** to open the Inbox Options popup menu.
- Select **Forward** from the popup menu.
- Type an address in the **To** field, or, select one or more names from the Address Book (see *Selecting a Contact from the Address Book* on page 22).
- Add any text to the **Msg** field to preface the forwarded message.
- Press **MENU** to open the Message Options popup menu and select **Send**. The message display and popup menu close automatically and the message is sent.

6.4 Deleting Messages

- Scroll to the message you want to delete.
- Press **MENU** to open the Inbox Options popup menu and select one of:
 - Delete** to delete a single selected message; alternatively, you may press **ALT-DEL**
 - Delete All Msgs** to delete all messages in your Inbox;
 - Delete Read Msgs** to delete all messages that are marked as Read. Messages marked as "Unread" will not be deleted.





If you have set the Confirm Delete option (**PREFERENCES** → **Options** → **Confirm Delete**) to "Yes", then you will be asked to confirm or cancel the deletion.

6.5 Erred Messages

An erred Message is a message with transmission errors. The system will eventually correct the message by re-transmitting the missing or "erred" parts. When the message gets corrected, it will be shown as an Unread message.

7. Managing Outgoing Messages

Messages that you send are stored in the Outbox. Each message has a symbol indicating its current status:

-  message transmission in progress
-  message successfully sent
-  message transmission pending (transmitter may be off, or network is busy)
-  message transmission failed.

Select **OUTBOX** in the Main Menu to display your sent messages.

7.1 Reviewing Sent Messages

You can read messages that you have sent in the same way that you read received messages:

1. Select **OUTBOX** in the Main Menu and scroll to the desired message.
2. Press the joystick to select and open the message for viewing.

7.2 Resending a Message

You can resend a message that was not sent successfully.

1. Select **OUTBOX** in the Main Menu to view messages that you have sent.
2. Scroll to the message you wish to resend.
3. Press **MENU** to open the Outbox Options popup menu and select **Resend** to resend the message to the same recipients as before.

7.3 Deleting Messages

Messages can be deleted from the Outbox.

1. Select **OUTBOX** in the Main Menu, and scroll to the message you want to delete. Note that you cannot delete a “transmission in progress” message.
2. Press **MENU** to open the Outbox Options popup menu and select one of:
Delete to delete a single selected message; alternatively, you may press **ALT-DEL**
Delete All Msgs to delete all messages in your Outbox.

If you have set the Confirm Delete option (**PREFERENCES** → **Options** → **Confirm Delete**) to “Yes”, then you will be asked to confirm or cancel the deletion.

8. Other Messaging Options

8.1 Creating Quick Text for Messages

Quick Text can be saved in your e80 so that you can quickly insert the text when composing messages. This is a way to create quick access to frequently used sentences or phrases. You can add or delete text items in the Quick Text menu.

Add a new Quick Text Item

1. Go to PREFERENCES → *Quick Text*.

```

QUICK TEXT
Where shall we meet?
Who will be there?
Thanks for your help.
  
```

2. Press **MENU** to open the Quick Text options popup menu.

QUICK TEXT	OPTIONS
Where shall w	▶New Quick Text
Who will be t	▶Edit
Thanks for yo	▶Delete
	▶Delete All

3. Select **New Quick Text** and enter the text in the Quick Text screen.

```

QUICK TEXT
Text:
Meet me for lunch.
  
```

4. When done, press **MENU** and select **Save**, then press **ESC** to exit.

When text is saved in Quick Text, it is added to the top of the current list of phrases or sentences in the Quick Text menu.

You can view your saved text by scrolling down through the menu, and pressing the joystick when the desired text is highlighted.

Edit an Existing Quick Text Item

1. In the Quick Text submenu, select the Quick Text item to be edited.
2. Press **MENU** to open the Quick Text Options popup menu and select **Edit**.

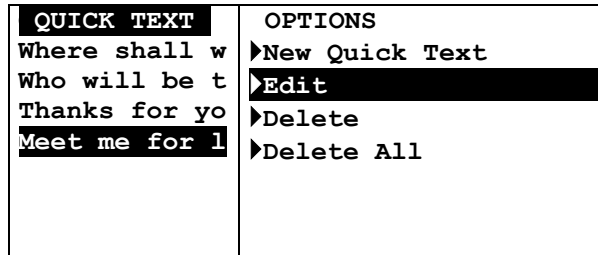

3. Make changes to the text in the Quick Text screen, then press **MENU** and select **Save**.
When the edited text is saved in Quick Text, you can view the new version of the text by scrolling down through the menu, and pressing the joystick when the desired text is highlighted.

Delete an Existing Quick Text Item

1. In the Quick Text submenu, select the item to be deleted.
2. Press **MENU** to open the Quick Text Options popup menu and select **Delete**.
3. Verify the deletion in the confirmation message that appears by selecting "Yes".
The deleted text item no longer appears in the Quick Text submenu.

8.2 Customizing the New Message Alert

You can change your Inbox Alert settings or turn the alert on or off.

1. Go to **PREFERENCES** → **Mailbox Alerts**.
The Mailbox Alerts submenu is displayed.

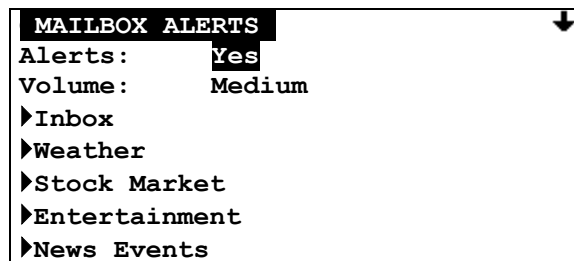

Arrow in upper right corner indicates that you can scroll down to see more mailboxes.

2. Set **Alerts** to "Yes" or "No" to enable or disable all mailbox alerts.
3. Set the **Volume** level to one of "Low", "Medium", or "High".

These two options apply to alerts for all mailboxes (i.e. includes both incoming mail and news messages).

4. Select **Inbox**.
The Inbox Alert submenu is displayed.

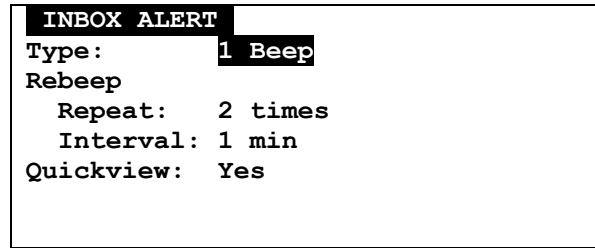

5. Set **Type** to your desired option. This may be one of Silent, Vibrate, Short-Vibrate, Beep-Vibrate, Beep 1, Double Beep, Chirp, Beethoven, Arpeggio, Attention, Wilhelm Tell, Dododo, Around, and Up & Down. (Press the **SPACE** key to play the alert; alternatively, you may play the alert within the Options popup menu by pressing **SPACE** or pushing the joystick →.)
6. Set **Rebeep Repeat** to one of: "None", a number from 1 to 5, or "Forever".
The alert will repeat for the number of times selected; "None" means only the original alert will sound (i.e. there is no rebeep).
7. Set **Rebeep Interval** to one of: "30 sec", "1 min", "2 min", "5 min", or "10 min".
If the Rebeep Repeat option is set to 1 or more, then the alert will repeat at the interval selected (every 30 seconds, 1 minute, 2 minutes, etc.).
8. Set **Quickview** to "Yes" or "No".
If Quickview is set to "Yes", then a New Message Received popup appears on the LCD display when a new message arrives. This is a quick way to view incoming messages: you can open the new message by selecting "Yes" in the popup, or you can close the popup by pressing any key.
9. Press **ESC** to save and exit from Inbox Alert.

8.3 Setting a Message Timestamp

You can also have your e80 timestamp messages:

1. Go to **PREFERENCES** → **Message Timestamp**.
The Timestamp submenu is displayed.

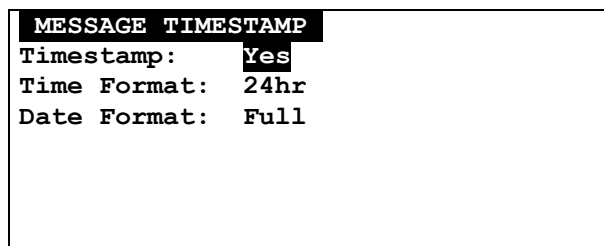

2. Set **Timestamp** to "Yes" (ON).
3. Set **Time Format** to "12hr" for 12-hour time format
or "24hr" for 24-hour time format.

4. Set **Date Format** to one of: "Full" (Feb 28, 2003),
"dd/mm/yyyy" (28/02/2003) or
"mm/dd/yyyy" (02/28/2003).
5. Press **ESC** to save and exit from Timestamp.

8.4 Creating an Automatic Signature

You can create a personal signature and add it automatically to any outgoing message.

1. Go to PREFERENCES → *Signature*.

SIGNATURE

Append: **Yes**

Signature:

2. In the **Append** field, select "Yes".
3. In the **Signature** field enter text for your personal signature. All of the text will be added to new messages, but only the text up to the first carriage return will be added to reply messages. It is a good policy to put your name, then a carriage return, followed by the rest of your signature (separated by additional carriage returns if necessary).
4. Press **ESC** to save and exit from Signature.

8.5 Saving Messages in the Personal Folder

You can move any message to your Personal folder in **FOLDERS**. For more information on folders, see *Managing Folders* on page 46.

1. Select **INBOX** or **OUTBOX** in the Main Menu, and scroll to the message you want to move.
2. Open the Inbox (or Outbox) Options popup menu and select **Move to Folder**.
3. Scroll to the subfolder you wish to store your message in and press the joystick to move the message into that folder.

The message is moved from the Inbox (or Outbox, or News) to the selected folder.

9. Managing the Address Book

You can store names and email or wireless addresses on your e80 for quick access when sending messages. You can also create groups that allow you to send messages to multiple recipients.

Select **ADDRESS BOOK** in the Main Menu to display the Address Book list of contacts.

Note: For shortcuts see **Shortcuts for Navigating on page 14**.

9.1 Adding a Contact to the Address Book

1. In the Address Book, press **MENU** to open the Options popup menu.

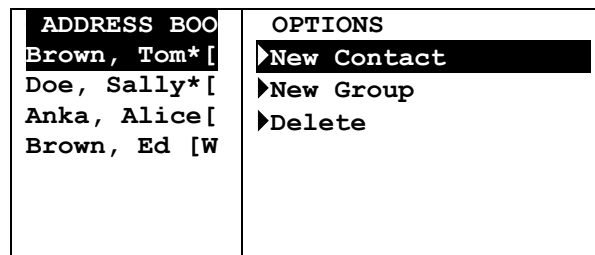

2. Select **New Contact** to display the New Contact screen and type the person's first name in the **First Name** field:

The screenshot shows the 'NEW CONTACT' screen. It has a title bar 'NEW CONTACT' with a downward arrow on the right. Below the title bar are several fields: 'First Name: Mike', 'Last Name:', 'Title:', 'Company:', and 'Wireless Addr:'. The 'First Name' field is filled with the text 'Mike'.

You can scroll down to see more fields to edit.

3. Continue to move down to each field and enter the appropriate text. Skip fields that you have no information for.
4. Set the **Usage** option field to "Normal" or "Frequent".
If Frequent is selected, the contact name will appear at the top of the Address Book list marked with an " * ".

- When done, press **MENU** to open the Options popup menu and select **Save** to save the new contact and return to the Address Book.

ADDRESS BOOK	OPTIONS
First Name: M	▶ Save
Last Name: La	▶ Set Defaults
Title: Servic	
Wireless Addr	
Home Email: M	

Or, press **ESC** to exit without saving.

9.2 Setting the Default Address within a Contact

When you create your contact if you don't explicitly set your default address, the topmost filled in address will become your default. A contact contains the following addressable fields:

- Wireless Address [WA]
- Work Email [WE]
- Home Email [HE]
- Alternate Email [AE]
- Work Phone [WP] (if enabled by your service provider)
- Home Phone [HP] (if enabled by your service provider)
- Mobile Phone [MP] (if enabled by your service provider)
- Fax Number [FX] (if enabled by your service provider)

For example, if you filled in Wireless Address and Home Email, then the default would be Wireless Address for that contact. If you wish to change the default address, or make other addresses also defaults, then do the following:

- In the Options popup menu above, select **Set Defaults**. The Set Defaults screen is displayed:

Lamb, Mike
•WA: 8876758
WA:MikeLamb@work.com

- Select all addresses or phone numbers that you want to use as default.
 - If more than address is selected, messages sent to this contact will be delivered to all selected addresses

- Phone number options will only appear if enabled by your service provider.
 - If you unselect all addresses, then the topmost address will be selected as the default.
3. When done, press **MENU** to open the Options popup menu and select **Update Contacts** to save your selections and return to the Edit Contact display.

<p>Lamb, Mike</p> <p>•WA: 8876758</p> <p>•WA: MikeLam</p>	<p>OPTIONS</p> <p>▶Update Contacts</p>
--	--

4. Press **MENU** again and select **Save** to save the new contact information and return to the Address Book. The new contact appears in the Address Book list.

<p>ADDRESS BOOK</p> <p>Brown, Tom* [WA]</p> <p>Doe, Sally* [WA]</p> <p>Anka, Alice [WA]</p> <p>Brown, Ed [WE]</p> <p>Lamb, Mike [WA, WE]</p>	<p>5 of 5</p>
--	---------------

9.3 Adding a Group to the Address Book

1. In the Address Book, press **MENU** to open the Options popup menu and select **New Group**.
2. In the New Group screen type a name for the group in the **Name** field.
3. Set **Usage** to "Normal" or "Frequent" (groups that are used most often and should appear at the top of the Address Book list).
4. Press **MENU** to open the Options popup menu and select **Edit Contact List** to view a list of existing contacts (but not groups) in your Address Book.
5. Scroll down the list and select each contact that you wish to add to the group.

<p>EDIT CONTACT LIST</p> <p>•Brown, Tom* [WA]</p> <p>•Doe, Sally* [WA]</p> <p>Anka, Alice [WA]</p> <p>Brown, Ed [WE]</p> <p>Lamb, Mike [WA, WE]</p>	<p>1 of 5</p>
--	---------------

You cannot add a manual address to a group; you can only add contacts that you have already created in your Address Book.

6. When done adding contacts, press **MENU** to open the Options popup menu and select **Done Selecting** to save the contact list and return to the New Group screen.
7. Press **MENU** and select **Save** from the Options popup menu to save the new group and exit to the Address Book.
Or, press **ESC** to exit without saving.

9.4 Viewing Contact or Group Information

1. In the Address Book, scroll to a contact or group you wish to view. The contact or group name is highlighted.

```

ADDRESS BOOK 1 of 5
Brown, Tom* [WA]
Doe, Sally* [WA]
Brown, Ed [WE]
Choir [grp]
Lamb, Mike [WA, WE]
    
```

- Contacts are listed alphabetically by last name, with frequent contact names (marked by “*”) at the top of the list.
 - Group names are indicated by “[grp]”.
 - The addresses that messages will be sent to are indicated for each contact:

[WA]	Wireless Address	[WP]	Work Phone
[WE]	Work Email	[HP]	Home Phone
[HE]	Home Email	[MP]	Mobile Phone
[AE]	Alternate Email	[FX]	Fax Number
 - Phone number options will only appear if enabled by your service provider.
2. Press the joystick to display detailed information about the selected contact:

```

Brown, Tom*
President
*WA: 5467329812@carrier.com
 WE: tom.brown@work.org
 HE: tbrown@home.com
    
```

- The “*” in the top line indicates that this is a frequent contact name.
 - “*WA” indicates that the Wireless Address is the address to which all messages for this contact will be sent.
 - “_WE” indicates that messages will not be sent to the Work Email address.
3. Press **ESC** to return to the Address Book contact list.

9.5 Editing a Contact or Group

1. In the Address Book, scroll down to the contact or group that you wish to edit. The contact or group name is highlighted.
2. Press the joystick to display address information for that contact or group.
3. Press **MENU** and select **Edit** in the Options popup menu.

EDIT CONTACT	OPTIONS
First Name: M	▶ Edit
Last Name: La	▶Set Defaults
Title: Servic	
Wireless Addr	
Home Email: M	

The Edit Contact or Edit Group screen is displayed, and you can make changes in any field, as required.

4. To edit a group contact list, press **MENU** and select **Edit Contact List** when the Edit Group screen is displayed.

EDIT GROUP	OPTIONS
Name: Choir	▶Save
Usage: Norma	▶ Edit Contact List
ebrown@home.	
606670932@ve	
513478890@ve	

5. Press **MENU** again and select **Save** when done to save and exit to the Address Book, or press **ESC** to exit without saving.

9.6 Deleting a Contact or Group

1. In the Address Book, scroll to the name of the contact or group that you wish to delete. The contact or group name is highlighted.
2. Press **MENU** and select **Delete** in the Options popup menu. Alternatively, you may press **ALT-DEL**. If you have set the Confirm Delete option (**PREFERENCES** → **Options** → **Confirm Delete**) to "Yes", then you will be asked to confirm or cancel the deletion.

The contact or group is deleted from the Address Book contact list.

10. Reading News

If you are subscribed to one or more news services, you can receive news messages.

Note: For shortcuts see **Shortcuts for Navigating** on page 14.

10.1 Reading a News Message

You can read a News message in the same way that you can read Inbox messages (see *Reading a Message* on page 26).

If a Quickview popup is displayed, then select "Yes" to view a new unread News message.

Or:

1. Select **NEWS** in the Main Menu.
2. Select a News folder in the News submenu.
3. Highlight the message you wish to read and press the joystick to display it.

10.2 Forwarding News

1. While the News message is displayed, press **MENU** to open the News Options popup menu and select **Forward Message**.

STOCK MARKET	OPTIONS
✉ *Market Upd	▶ Forward
✉ *Market Upd	▶ Delete
📁 *Market Up	▶ Move to Folder
📁 *Market Upd	▶ Delete All Read
📁 *Market Upd	▶ Delete All Msgs
[ate*---Dow	
[Indu 2293.90	

Status icons for News messages are the same as the status icons for Inbox messages.

The Forward A Message screen is displayed.

2. Follow the instructions for *Forwarding a Message* on page 29.

10.3 Deleting News

You can delete any or all News messages. News messages will also be deleted automatically when a new message is received and your News folder is already full.

Automatic Deletion when News is Full

When your News folders become full, your e80 will automatically delete News messages to make room for a new incoming News message. The order of priority for automatic message deletion is:

1. The oldest messages marked as Read are deleted first.
2. If all Read messages have been deleted, then the oldest Unread messages will be deleted.

Note that any News messages saved in the Personal folder will not be deleted.

Delete News Messages while in a News Subfolder

To delete News messages yourself:

1. While a News message is highlighted in the News menu, press **MENU** to open the News Options popup menu and select one of:

Delete	delete the selected message
Delete All Read	delete all messages marked as Read in this folder
Delete All Msgs	delete all messages in this folder.

STOCK MARKET	OPTIONS
☐ *Market Upd	▶ Forward
☐ *Market Upd	▶ Delete
☐ *Market Upd	▶ Move to Folder
☐ *Market Upd	▶ Delete All Read
*Market Upd	▶ Delete All Msgs
[ate*---Dow	
[Indu 2293.90	

Or:

After opening a News message for viewing, press **MENU** to open the News Options popup menu and select **Delete**.

2. If you have set the Confirm Delete option (**PREFERENCES** → **Options** → **Confirm Delete**) to "Yes", then you will be asked to confirm or cancel the deletion.

Depending on the option selected, the selected News message, all News messages marked as Read, or all News messages will be deleted.

Delete News Messages while in the News Menu

Alternately, you can delete messages as follows:

1. While a News folder is highlighted in the News menu, press **MENU** to open the News Options popup menu and select one of:

- Delete Read Msgs** - delete all messages marked as Read in *this* News folder
- Delete** - delete all messages in *this* News folder
- Delete All Read** - delete all messages marked as Read in *all* News folders
- Delete All Msgs** - delete all messages in *all* News folders.

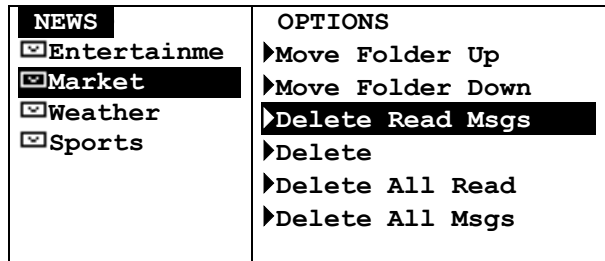

Note that News messages saved in the Personal folder in **FOLDERS** will not be deleted using any of these Delete options.

2. If you have set the Confirm Delete option (**PREFERENCES** → **Options** → **Confirm Delete**) to “Yes”, then you will be asked to confirm or cancel the deletion.

Depending on the Delete option selected, all News messages or all News marked as Read, will be deleted in the selected folder, or in all folders (but not in the Personal folder).

10.4 Reordering News Folders

1. Select a News folder, press **MENU** to open the News Options popup menu and select one of:
Move Folder Up
Move Folder Down.

10.5 Customizing News Alerts

You can turn alerts on or off and change the volume for all alerts (both News and Inbox), or modify the type of alert for different kinds of News messages.

1. Go to **PREFERENCES** → **Mailbox Alerts**.
The Mailbox Alerts submenu is displayed.

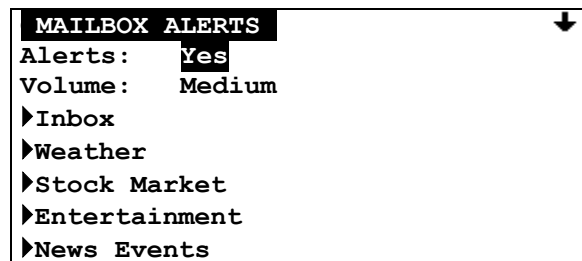

2. Set **Alerts** to “Yes” (ON) or “No” (OFF) and set the **Volume** level to one of “Low”, “Medium”, or “High”.

Note that this affects both Inbox and News messages; do not make changes to these two items unless you intend them for all message alerts.

3. Select one of the News types (*Weather, Stock Market, etc.*) that you wish to set an alert for. The News Alert Options submenu is displayed.

WEATHER ALERT	
Service:	Yes
Type:	Vibrate
Quickview:	Yes
History:	4

Set News Alert Options

1. Set **Service** to either:
 "Yes" (receive a message and create folder for it) or
 "No" (message will not be received and associated folder will be deleted).
2. Set **Type** to your desired option. This may be one of Silent, Vibrate, etc.
3. Set **Quickview** to either "Yes" or "No".

If Quickview is set to "Yes", then a New Message Received popup appears on the display when a new message arrives. This is a quick way to view incoming News messages: you can open the new message by selecting "View Message" in the popup, or you can close the popup by pressing any **ESC**.

4. Set **History** to a number from 1 to 8 for the maximum number of messages to be stored in the folder.

When the maximum number for a folder is reached, then your e80 will automatically delete messages from that folder according to the deletion rules for *Automatic Deletion when News is Full* on page 41. Messages will also be deleted when the e80 runs out of News message memory.

10.6 Saving News in the Personal Folder

You can archive any News message in your Personal folder in **FOLDERS**. For more information on folders, see *Managing Folders* on page 46.

1. After selecting the News message for viewing, press **MENU** to open the News Options popup menu and select **Move to Folder**.
2. Scroll to the folder or subfolder where you wish to store your message and press the joystick to move the message into that folder.

The message will be moved from your News folder to your Personal folder.

11. Creating and Managing Memos

You can create and save memos (i.e. text files) on your e80. These memos can be added to messages that you send out.

Note: For shortcuts see Section 3.5 Shortcuts for Navigating on page 14

11.1 Creating a Memo

You can create and store memos in **FOLDERS** on your e80.

1. Go to **FOLDERS** → **Memos** and press **MENU** to open the Memo Options popup menu.

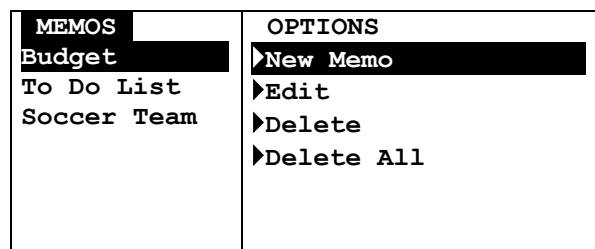

2. Select **New Memo** to open the New Memo screen.

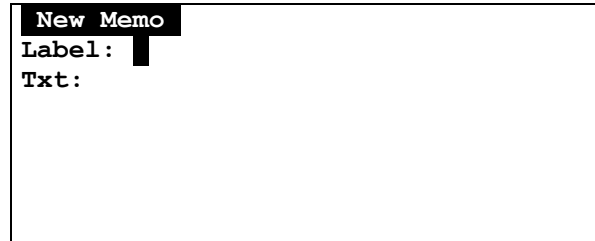

3. Enter a name for your memo in the **Label** field. For example: *Shopping*.
4. Enter the memo text in the **Txt** field. For example: *Pickup tomato sauce, noodles, peppers*.
5. Press **MENU** to open the Memo Options popup menu and select **Save**. The memo and the popup menu close and the memo label (*Shopping*) appears in the Memos folder.
Or, press **ESC** to exit without saving.

11.2 Viewing a Memo

To read a memo you have already created:

1. Go to **FOLDERS** → **Memos** and scroll to the desired memo.
2. Press the joystick to display the memo text.

11.3 Editing a Memo

1. Go to **FOLDERS** → **Memos** and scroll to the memo to be edited.
2. Press **MENU** to open the Memo Options popup menu and select **Edit**.
3. Make any changes in the Edit Memo screen.
4. Press **MENU** to open the Memos Options popup menu again and select **Save**.
The changes are saved and the memo and popup menu are closed.
Or, press **ESC** to exit without saving.

11.4 Deleting a Memo

1. Go to **FOLDERS** → **Memos** and scroll to the memo to be deleted.
2. Press **MENU** and select **Delete** in the Memo Options popup menu. Alternatively, you may press **ALT-DEL**. If you have set the Confirm Delete option (**PREFERENCES** → **Options** → **Confirm Delete**) to "Yes", then you will be asked to confirm or cancel the deletion.
The memo is deleted from the folder submenu.

11.5 Inserting a Memo into a Message

You can insert a memo into an outgoing message (in **SEND A MESSAGE**).

1. With the cursor in the **Msg** field of a new outgoing message, press **MENU** to open the Options popup menu.

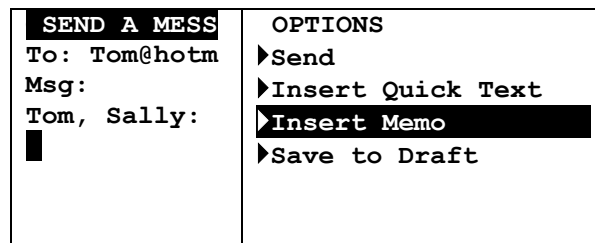

2. Select **Insert Memo** from the popup menu.
A list of memos is displayed.
3. Select the desired memo from the list.
The text of the memo is inserted at the cursor in the message field.
4. When done, press **MENU** to open the Message Options popup menu and select **Send**.

12. Managing Folders

You can store messages, news, memos and any text files in your e80 Folders. You can create subfolders in the Personal subfolder for organizing the messages that you save there. When you select **FOLDERS** from the Main Menu, 4 subfolders are displayed:

- **Drafts** - for messages being created or edited
- **Memos** - for memos that you create
- **Personal** - for storing mail and news messages.
- **Help** - for viewing help

12.1 Creating a New Subfolder for Mail or News Messages

You can create subfolders in the Personal folder for organizing your saved mail or news messages.

1. Select **FOLDERS** in the Main Menu.
2. Select the Personal folder.
You cannot create new subfolders in the Draft or Memos folders.
3. Press **MENU** to open the Folder Options popup menu.

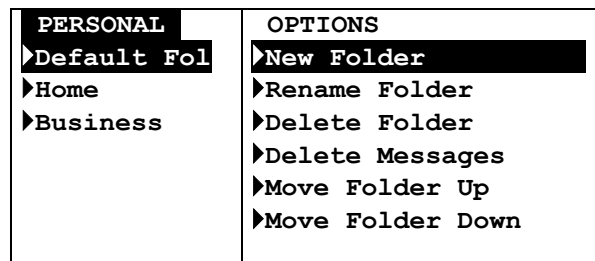

4. Select **New Folder** in the popup menu to open the New Folder screen.

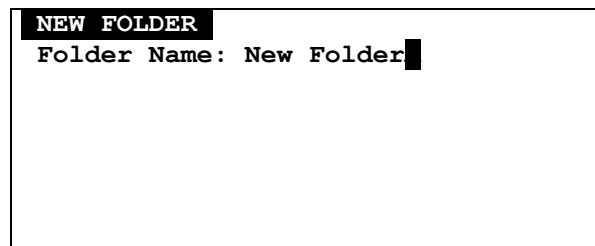

5. Delete the default name 'New Folder' by pressing **ALT** then **DEL**. If you have set the Confirm Delete option (**PREFERENCES** → **Options** → **Confirm Delete**) to "Yes", then you will be asked to confirm or cancel the deletion.
6. Type a name for the new subfolder.

- Press **MENU** to open the Folder Options popup menu again and select **Save**. The New Folder submenu closes and the new subfolder appears in the Personal folder submenu.

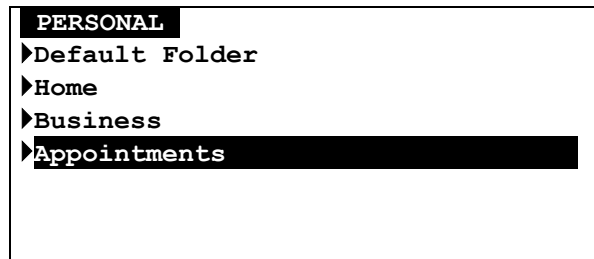

Or, press **ESC** (or select **Cancel** from the Options popup menu) to exit without saving.

12.2 Editing a Subfolder Name

You can change any subfolder name by selecting it in the Folders menu, pressing **MENU** to open the Folder Options popup menu, and selecting **Rename Folder**.

12.3 Deleting Subfolders

You can delete a subfolder by selecting **Delete Folder** in the popup menu. Note that you cannot delete the Default Folder.

12.4 Managing Draft Messages

You can Delete messages saved in the Drafts folder, by pressing **MENU** to open the Folder Options popup menu, and then selecting **Delete** to delete the highlighted message or **Delete All Msgs** to delete all messages in the folder.

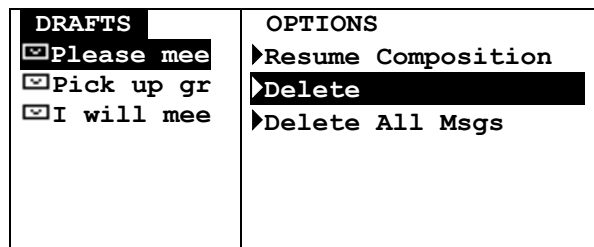

You can send messages saved in the Drafts folder, by viewing a draft message, pressing **MENU** to open the Options popup menu, and then selecting **Resume Composition**.

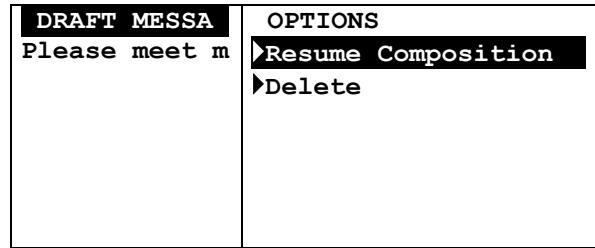

Resume Composition will move the message into the Send a Message application automatically. You can continue composing your message and then send it.

12.5 Managing Personal Messages

Depending on the type of message, messages saved in your Personal folder can be Resent, Forwarded, Replied To, Deleted or Moved to another folder.

- Messages saved from the Inbox can be Replied To and Forwarded
- Messages from the Outbox can be Forwarded and Resent
- Messages saved from News messages can be Forwarded.

All messages can be Deleted or Moved to another folder.

To Reply, Forward, Delete or Move a message:

1. Select **FOLDERS** in the Main Menu, then select the Personal folder.
2. Select the appropriate subfolder.
3. Select the message you want to work with, and press **MENU** to open the Folder Options popup menu.

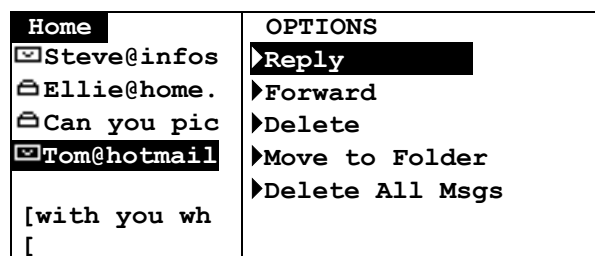

Reply only appears for Received personal messages

4. Select the desired option. For more information, see the same commands described in *Managing Incoming Messages* on page 26, or *Managing Outgoing Messages* on page 29.

13. Setting Personal Options

Your e80 comes with certain options already set for you. You can change any of the options listed in the Preferences Menu and save them.

To start, select **PREFERENCES** in the Main Menu.

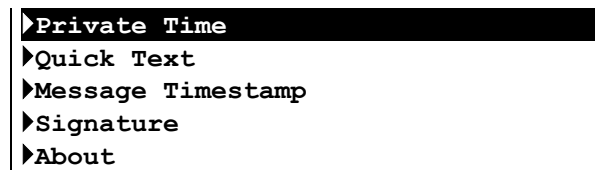
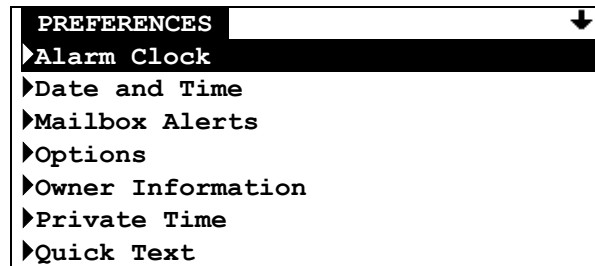

Arrow indicates that you can scroll DOWN to see more.

“Alarm Clock”, “Options”, and “Private Time” settings are described in this chapter.

Other Preference settings are described in the following places:

- “Date and Time” settings on page 19
- “Mailbox Alerts” settings on page 32
- “Owner Information” settings on page 18
- “Quick Text” settings on page 31
- “Message Timestamp” settings on page 33
- “Signature” settings on page 34
- “About” information on page 17.

13.1 Setting Up the Alarm Clock

You can set one or two alarms on your e80. For example, you may set Alarm #1 for a wake-up time on weekdays and Alarm #2 for a weekend wake-up time.

1. Go to **PREFERENCES** → **Alarm Clock**.
The Alarm Clock menu is displayed.

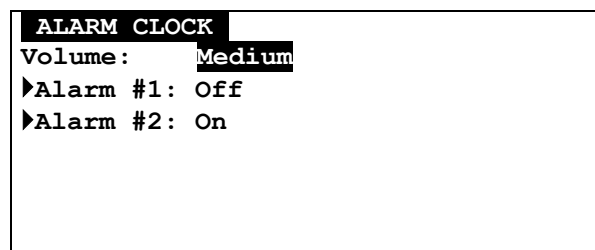

- Set **Alert Volume** to one of “High”, “Medium”, or “Low”.

In the Alarm Clock menu, you can see whether either alarm is set On or Off. To set an alarm that is currently Off, do the following:

- Select **Alarm #1** (which is currently set OFF) to open the Set Alarm #1 submenu.

SET ALARM #1	
Alarm Clock:	Off
Frequency:	Once
Time:	[HH] : [MM] [AM]
Alert Type:	Beep 1
Snooze:	Yes
Comment:	

- In the Alarm #1 submenu you can make the following changes:
 - Alarm Clock:** set to “On” or “Off”
 - Frequency:** set how often the alarm alert should sound
 - “Once” (only one occurrence, at the set time),
 - “Daily” (every day at the set time),
 - “Weekday” (every Mon., Tues., Wed., Thurs. and Fri. at the set time), or
 - “Weekend” (every Sat. and Sun. at the set time).
 - Time:**
 - If Date and Time **Time Format** is set to 12 hour format: set the hour (01–12), minute (00–59) and AM or PM for the alarm alert
 - If Date and Time **Time Format** is set to 24 hour format: set the hour (00-23), and minute (00–59) for the alarm alert
 - Alert Type:** set to your desired option. This may be one of Silent, Vibrate, etc.
 - Snooze:** “Yes” (alarm alert will sound up to 3 more times at 10 minute intervals) or “No” (only one alarm alert at the set time). If Snooze is enabled then the alarm icon will flash in the Main Menu when the alarm alert is triggered, and continues to flash until the alarm is turned off.
 - Comment:** enter text to describe Alarm (e.g., *Dental appointment*); this will appear in the Alarm Alert popup.
- When done, save and exit from the Alarm #1 submenu and return to the Alarm Clock menu.
- You can select **Alarm #2** and make similar changes there as well.
- Press **ESC** to save and exit from Alarm Clock.

13.2 Alarm Alerts

When the alarm alert is triggered, an alarm alert screen appears on top of whatever was currently being displayed. Press any key to stop the alarm. The popup remains onscreen until you close it or turn off the alarm.

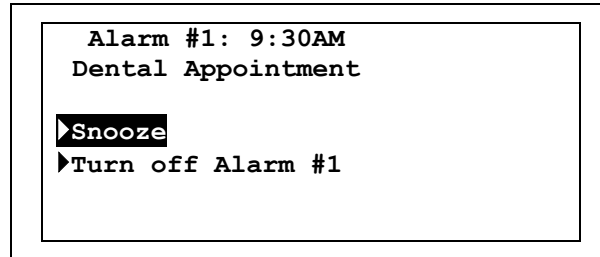

Close the Alarm Alert Popup

Select **OK** from the Alarm Alert popup menu (Snooze is OFF). The popup will close and not reappear.

Or:

Select **Snooze** from the Alarm Alert popup menu (this option replaces “OK” when Snooze is ON). The popup closes and will reappear in 10 minutes when the alarm alert is repeated. The alarm icon in the Main Menu continues to flash between alerts.

Turn Off and Reset the Alarm

Select **Turn Off Alarm** from the popup menu.

The alarm is set to the next alarm time (for example, next day at same time), if any, and the popup is closed.

13.3 Customizing Display Features

You can customize your e80 display with a number of display options.

1. Go to **PREFERENCES** → **Options** to open the Options submenu.

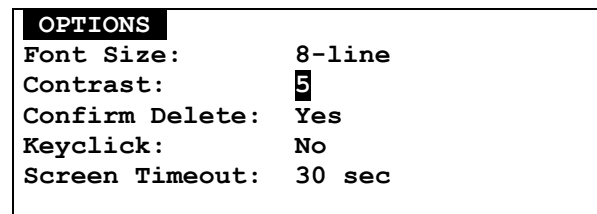

2. Make changes in the Options submenu as desired. Push the joystick **↑** or **↓** to move from field to field, and press the joystick to change options in each field.
 - **Contrast:** Set the LCD display contrast to a number from 1 (low) to 10 (high).
 - **Confirm Delete:** for a confirmation message whenever you delete a message/memo/text, set to “Yes”, or “No” (no confirmation message will be displayed).

- **Font Size:** Set to “5-line” for larger font or “8-line” (default) for smaller font.

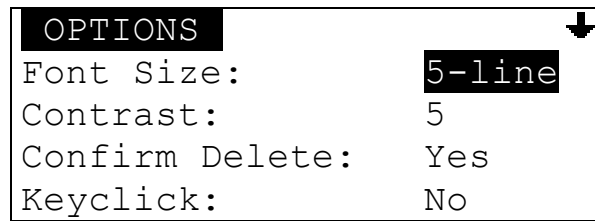

Display screen with 5-line font selected

- **Keyclick:** Set to “Yes” for an audible click whenever the joystick or any key is pressed, or “No” for no click.
- **Screen Timeout:** Set to “30 sec”, “60 sec” or “Off”.

After the e80 has been idle for the selected length of time, the LCD screen will go blank to conserve energy. If the back light is on, it will turn off.

If set to “Off”, then the screen will remain on until the device is turned off.

- **Message Privacy:** If your e80 is enabled for Message Privacy, then you can set this option to “Yes”. This means that if the network requests the “read” status of a message sent to you, the device will inform the network that the device is currently set to private.

If set to “No”, or if Message Privacy is not enabled for your device, then the device will respond to any network “read” status requests.

3. Press **ESC** to save and exit from Options.

13.4 Setting Private Time

Private Time allows you to turn off Inbox and News Message Alerts for a specified period of time every day (for example, when you are asleep at night). To configure Private Time:

1. Go to **PREFERENCES** → **Private Time**.

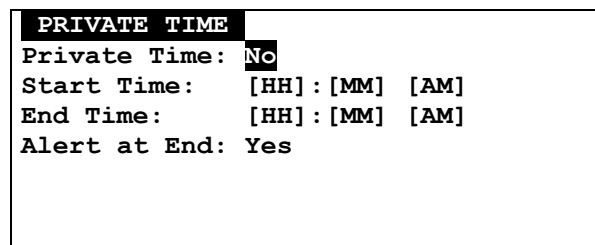

2. Set **Private Time** to “Yes” to turn on Private Time.
3. Enter the **Start Time** by clicking in each field until the desired number or option appears:
 If Date and Time **Time Format** is set to 12 hour format: set the hour (01–12), minute (00–59) and AM or PM
 If Date and Time **Time Format** is set to 24 hour format: set the hour (00–23), and minute (00–59)

4. Enter the **End Time** by clicking in each field until the desired number or option appears:
If Date and Time **Time Format** is set to 12 hour format: set the hour (01–12), minute (00–59) and AM or PM
If Date and Time **Time Format** is set to 24 hour format: set the hour (00–23) and minute (00–59)
5. Set **Alert at End** to “Yes” (default) or “No”.
When set to Yes, an alert sounds at the end of Private Time if new messages are in the Inbox.
6. Press **ESC** to save and exit from Private Time. Private Time is now turned on and will go into effect for the selected time period (from Start Time to End Time).

14. Maintenance

14.1 General Care

Clean with a soft cloth dampened with soap and water.

Do not immerse in water. Do not use alcohol or other cleaning solutions.

Do not expose to excessive heat or extreme shock or moisture.

14.2 Battery Care

The Battery Life Status Indicator will flash on the e80 LCD display screen when the battery needs recharging. Charge the battery as per the instructions in Section 2.4 Charging the Battery on page 7.

Removing and Replacing the Battery

Under normal circumstances your PerComm lithium ion battery should not need replacing for many years. If you do need to replace it, follow these instructions.

First, remove the old battery from the battery cabinet:

1. On the rear side of the e80, remove the battery cover by pressing down and outwards (in the direction of the arrows imprinted on the cover) on the cover thumb grip.
2. Grip the battery at the thumb hole on the lower side of the battery cabinet and pull the battery upwards and out.

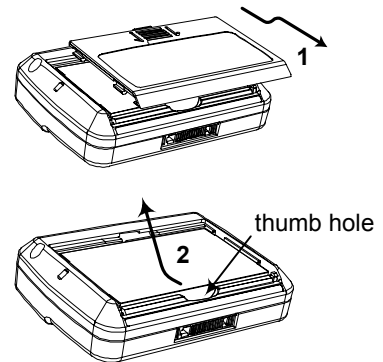

Now, place the new battery in the battery cabinet as per instructions in Section 2.3 Installing the Battery on page 6.

15. Troubleshooting

- e80 does not turn on** *Press **ALT** then **SPACE** to turn the e80 on.*
Check the battery: ensure battery is charged, inserted properly, and that the contacts are clean.
- You can't send messages** *Check the signal strength meter if there is one.* If the signal is weak, move to an open space or, if in a building, move close to a window.
Check your coverage icon. Ensure you have 2-way coverage; if not then there may not be network coverage in your area.
Check your transmitter icon. Is the Transmitter Off? If so, turn on.
- You can't receive messages** *Check the signal strength meter if there is one.* If the signal is weak, move to an open space or, if in a building, move closer to a window.
Check your coverage icon. Ensure you have 2-way coverage; if not then there may not be network coverage in your area.
Check your transmitter icon. Is the Transmitter Off? If so, turn on.
- The battery won't charge** *Check the charger.* Ensure the charger is properly plugged in, and that the wall outlet has power.
Check the battery contacts. Ensure contacts are clean.
Check the battery temperature. If it is warm, let it cool before recharging.
Is it an old battery? Replace the battery.
Are you using a PerComm original battery? The e80 is only designed to work with PerComm lithium ion batteries.
- The battery loses charge faster than normal** *Are you in an area of variable coverage?* This consumes more power.
Is it a new battery? A new battery needs two to three charge/discharge cycles to attain normal performance.
Is it an old battery? Battery performance declines after several years of use.
Are you using your e80 in extreme temperatures? At extreme hot or cold temperatures, battery performance is significantly reduced.

16. FCC Compliance Statement

This device complies with part 15 of the FCC Rules. Operation is subject to the following two conditions:

1. This device may not cause harmful interference
2. This device must accept any interference received, including interference that may cause undesired operation.

This device has been tested and found to comply with the limits for a Class B digital device, pursuant to part 15 of the FCC Rules. These limits are designed to provide reasonable protection against harmful interference in a residential installation. This device generates, uses and can radiate RF energy and, if not setup and used in accordance with the instructions, may cause harmful interference to radio communications. However, there is no guarantee that interference will not occur due to a particular use of the device. If this device does cause harmful interference to radio or television reception, which can be determined by turning the device off and on, the user is encouraged to try to correct the interference by one or more of the following measures:

- Reorient or relocate the receiving antenna
- Increase the separation between the device and receiver
- Connect the device into an outlet on a circuit different from that which the receiver is connected
- Consult the dealer or an experienced radio/TV technician for help.

Index

- address book
 - adding a new contact, 36
 - adding a new group, 38
 - deleting a contact or group, 40
 - editing a contact or group, 40
 - set default addresses, 37
 - shortcuts, 16
- alarm clock
 - alert, closing and turning off, 52
 - indicators/icon, 11
 - setting snooze mode, 51
 - setting up, 50
- alerts
 - alarm, closing and turning off, 52
 - inbox, 33
 - news, 43
 - playing, 34
 - setting indicator, 11
 - turn off/on, 21
- ALT key, 13
- automatic deletion
 - Inbox, 17
 - news, 42
 - personal memory, 17
- back light, turning it on/off, 9
- battery
 - care, 55
 - charge indicator, 11
 - charging, 7
 - installing, 6
 - loses charge too fast, 56
 - removing, 55
 - won't charge, 56
- charging the battery, 7
- confirm delete popup, setting, 53
- contact list
 - in groups, 38
- contacts
 - adding to address book, 36
 - sending messages to, 23
 - setting the default address, 37
- control keys, 13
- coverage indicator, 11
- customizing display features, 52
- date, setting, 20
- DEL key, 13
- deleting messages, 30, 31
- display contrast, setting, 52
- draft messages, editing, deleting, sending, 48
- Drafts Folder, saving to, 24
- ENTER key, 13
- erred messages, 30
- ESC key, 13
- external connector, 9
- folders
 - creating a subfolder, 47
 - deleting a memo, 46
 - deleting subfolders, 48
 - draft messages, managing, 48
 - editing a subfolder name, 48
 - insert memo in message, 46
 - moving mail messages to, 35
 - moving news messages to, 44
 - new memo, 45
 - personal messages, managing, 49
 - viewing a memo, 45
- font size, setting, 53
- forwarding messages, 30
- function keys, 13
- go to main menu, 13, 21
- go to status icons, 21
- groups, adding to address book, 38
- inbox
 - customizing incoming message alert, 33
 - deleting messages, 30
 - erred messages, 30
 - forwarding a message, 30
 - message symbols, 27
 - reading a message, 27
 - replying to a message, 29
- installing the battery, 6
- joystick, shortcuts, 15
- joystick, using the, 15
- keyboard
 - locking, 22
 - shortcuts, 15
 - using the, 12
- keyclick, setting, 53
- lanyard, 6
- LCD display, 10
 - contrast adjustment, 52
 - customizing, 52
 - main menu icons, 10
 - status indicators/icons, 11
 - turning back light on/off, 9
- lowercase/uppercase characters, typing, 13
- main menu, 10
 - popup menu, 21
- main menu icons on the LCD display, 10
- memos
 - creating, 45
 - deleting, 46

- inserting in messages, 46
 - shortcuts, 15
 - viewing, 45
- MENU key, 13
- messages
 - automatic deletion, 17
 - can't receive, 56
 - can't send, 56
 - deleting, 30, 31
 - erred, 30
 - forwarding, 30
 - incoming, 27
 - new unread indicator, 11
 - privacy, 53
 - reading, 27, 31
 - replying to, 29
 - resending, 31
 - saving, 35
 - saving to Drafts Folder, 24
 - sending. *See* sending messages
 - shortcuts, 15
 - timestamp, 34
 - transmission, turn off/on, 21
- navigating the e80 menus, 15
- news
 - automatic deletion when news is full, 42
 - customizing news alerts, 43
 - deleting, 42
 - forwarding a news message, 41
 - reading a message, 41
 - reordering news folders, 43
 - saving messages in the personal folder, 44
- numbers, typing, 13
- outbox
 - deleting messages, 31
 - message symbols, 31
 - resending a message, 31
 - reviewing sent messages, 31
- owner information, 19
- personal folder, managing messages in, 49
- personal memory, 17
- power connector, 9
- power off/on, 10, 13, 20, 21
- preferences menu, 50
 - about, 18
 - alarm clock, 50
 - mailbox alerts, 33, 43
 - options, 52
 - owner information, 19
 - private time, 53
 - signature, 35
 - timestamp, 34
- privacy, 53
- private time, setting up, 53
- quick text
 - creating, 32
 - deleting, 33
 - editing, 33
 - shortcuts, 15
 - using in a message, 26
- quickview
 - enabling, 34, 44
 - using, 27, 41
- reading a message, 27
 - shortcuts, 15
- reading a news message, 41
- replying to a message, 29
- resending a message, 31
- reviewing sent messages, 31
- safety information, 4
- saving messages in folders, 35, 44
- sending messages, 23
 - composing, 25
 - editing manual entries, 25
 - inserting a memo, 46
 - saving to Drafts Folder, 24
 - selecting contacts from Address Book, 23
 - to non-default contact addresses, 24
- serial connector, 9
- setting personal options, 50
- setting up your e80, 18
- SHIFT key, 13
- shortcuts, 15
- signal strength indicator, 11
- signature, creating a, 35
- snooze mode
 - indicator, 11
 - setting, 51
- special characters, typing, 13
- status indicators/icons, 11
- subfolders. *See* folders
- system status indicators/icons, 11
- time, setting, 20
- timeout, setting screen, 53
- timestamp, setting a message, 34
- transmission, message
 - indicator, 11
 - turn off/on, 21
- transmitter off/on, 21
- troubleshooting, 56
- uppercase/lowercase characters, typing, 13
- viewing system information, 18